

"L" - .5"
TILE INSERT

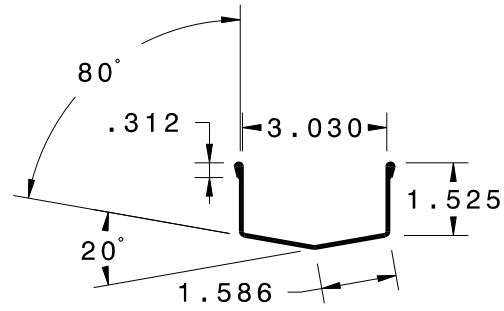

"L" CAN BE TRIM BY CUSTOMER
DRAIN PAN

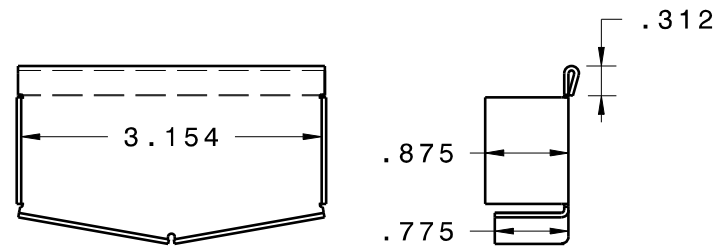

END CAP

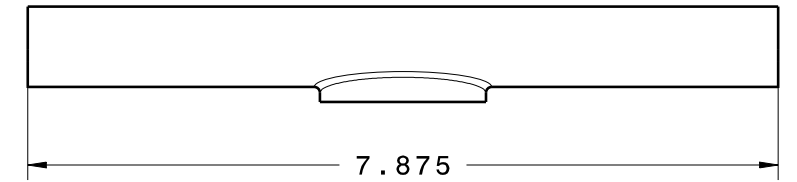
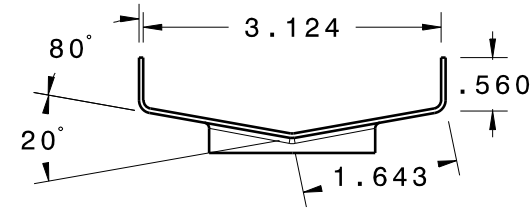

EXTRUDED DRAIN

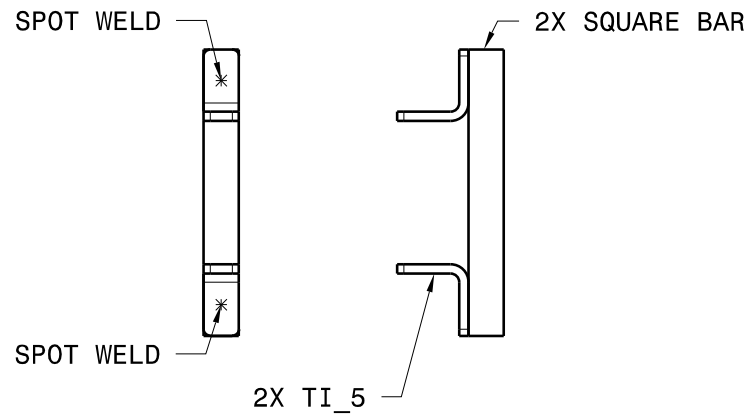

END_SUPPORT_ASSY

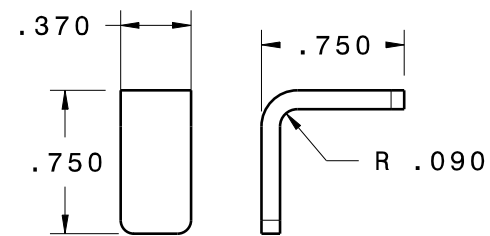

TI_5

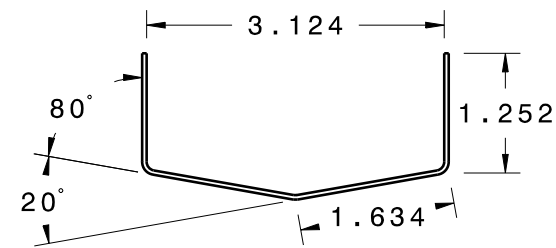

SPLICE